

Low VOLTAGE 50 and 60 Hz Motor
Installation and Maintenance Manual >>>

DN: 195-0014
Rev. 003



Leading Innovation >>>

Low-Voltage Motor Instruction Manual

Installation and Maintenance for Polyphase 50 and 60 Hz AC Motors

Frame Size

- Frames 143 through 5810 Open Drip Proof (ODP)
- Frames 56 through 5811 Totally Enclosed Fan Cooled (TEFC)
- Frames 143 through 449 Expulsion Proof (XP)
- Frames 56 through 5811 Totally Enclosed Air-Over (TEAO)
- Frames 56 through 449 Totally Enclosed Non-Ventilated (TENV)
- Frames 143 through 5811 Totally Enclosed Blower Cooled (TEBC)



WARNING

- To reduce the risk of fire or explosion, do not install Division 2 motors in areas where the operating temperature code (shown on the motor nameplate or Division 2 label) exceeds the ignition temperature of the hazardous environment.
- Do not attempt to install, operate, maintain or dispose of this equipment until you have read and understood all the product safety information and directions that are contained in this manual.
- Do not disable or bypass any safety guards or protective devices.
- Avoid touching the hot surfaces of the electric motor without wearing proper protection.
- Keep the terminal box cover in place and secured while the motor circuits are powered.
- Two people are required to lift a 140 frame motor.
- Hearing protection is required around noise levels exceeding 80 dBA.
- Protection for overloads, peak starting currents, short circuit current, and ground fault currents, should be in strict accordance with the National Electrical Code (latest release) Article 430, local electrical codes, and building codes.
- Proper circuit protection is required to prevent automatic reset devices from automatically restarting the motor.
- Only qualified personnel are to perform maintenance in an effort to prevent equipment failure or damage.

Notes

- Each Toshiba International Corporation (TIC) electric motor is thoroughly tested at the factory and carefully packaged for standard shipping. Confirm the overall packaging condition upon receipt.
- The equivalent lead wire markings per NEMA(IEC) are: T1(U1), T2(V1), T3(W1), T4(U2), T5(V2), T6(W2), T7(U5), T8(V5), T9(W5), T10(U6) T11(V6), T12(W6).
- All dimensions are in inches. Multiply inch value by 25.4 to convert to millimeters (mm).
- Any motor operated using an Adjustable Speed Drive is subject to potential premature bearing failures due to the increased shaft currents caused by common mode voltages inherent with operation on a sinusoidal power source. TIC recommends insulating both bearings on frame sizes 444 and larger. Smaller motors are at risk as well and should be considered after review of the application and installation. The user is responsible for protecting the couplings and driven

equipment from shaft currents from the motor. Insulated couplings are recommended. Shaft grounding devices provide additional protection, but cannot be used in hazardous areas because of electrical arcing.

- Contact TIC for a complete copy of the TIC **Standard Motor Warranties HBB0001** policy.
- Match the nameplate rating of the motor, connection diagram, and lead numbers with the appropriate category for the applicable connection requirement. TIC special built or special rated motors may follow different connections. If more information is required, contact TIC with the nameplate Model Number and Serial Number of the motor for connection information.
- EQP GLOBAL motors in frames 143T – 184T and all other TIC motors rated 0.5 HP – 5 HP are Wye-connected motors. All other standard size TIC motors are Delta-connected.
- TIC standard motors are built to F-1 assembly specifications. The motor uses the standard connection configuration and, while facing the non-drive end of the motor, the standard rotation is counter-clockwise (CCW).
- For references to the National Electrical Code (NEC) see the latest release of the NEC.
- All products and company names in this document are trademarks or registered trademarks of the respective owners and are used for identification purposes.

Storage

If the equipment is not put into immediate use, it should be stored indoors in an area that is clean and dry. Care should be taken to keep the equipment covered when moving from a cold location to a warm location, otherwise condensation may occur. If condensation does occur, allow the motor to dry thoroughly before applying power. Using a megohmmeter, test the insulation resistance of the windings before applying power. A minimum of 10 megohms is recommended.

For long-term storage or when indoor storage is not available, the motor must be covered with plastic or weather-proof tarp. Cover the motor completely. To ward off the formation of condensation, do not wrap the motor tightly. This will allow for adequate ventilation. Precautions must also be taken to protect the motor from flooding or being exposed to harmful chemical vapors.

Ensure that any unpainted sections are covered. Retouch any scratched or flaked areas.

If condensate plugs or drain plugs are used, ensure that they are functional.

Whether indoors or outdoors, the area should be free from vibration. Excessive vibration can cause bearing damage. Any motor which must be stored in an area that is exposed to vibration must have the shaft locked to prevent any movement.

If the motor is equipped with space heaters, ensure that the space heaters are properly connected and functional. The motor interior temperature should be maintained approximately 5.6° C (10° F) degrees above ambient.

A systematic inspection and maintenance schedule should be established. If the motor is to be stored for 6 months or longer, it should, in addition to the minor precautions above, have the insulation resistance of the windings tested every 3 to 6 months. A minimum of 10 megohms is recommended. A record of insulation values, temperature, time, humidity, and length of voltage application should be recorded to show winding conditions prior to start up.

If windings are designed for outdoor operation, they will not be affected by extreme or sudden temperature changes, or inclement weather in general. However, a weather proof cover with provisions for adequate ventilation should be used to guard against intrusion of salt, dust, or other abrasive or corrosive material.

It is recommended that the rotor be turned every month to redistribute the lubricant in the bearings. Oil or grease should be added every 6 months.

— READ THE FOLLOWING CAREFULLY BEFORE INSTALLING OR STARTING MOTOR —

Receiving

1. Ensure that the nameplate data is consistent with the order specifications.
2. Check whether any damage has occurred during transportation. Typically, motors are shipped FCA TIC factory. Freight Claims must be submitted by the consignee to the carrier.

3. Remove the bearing lock plate before start up (if used). Save the plate for reuse if subsequent shipping is required.

Note: *If unable to reinstall the bearing lock plate, use wooden wedges to block the shaft to prevent any movement during shipping.*

4. Turn the shaft by hand to ensure that it turns freely.

Location

1. The motor should be installed in an area of unrestricted ventilation. Ensure that there are no limits or obstructions imposed on the operation of the motor.
2. Drip Proof motors are designed for indoor installations in a well ventilated area where the atmosphere is reasonably free of dirt, moisture, and corrosion. Contact TIC for any required modifications.
3. Totally enclosed motors may be installed where dirt, moisture (not running water), and corrosion are present. Outdoor applications are acceptable, subject to the environment. Contact TIC for any required modifications.
4. Explosion Proof motors are designed and built for hazardous locations. Listed by U L for Class 1, Group D; and Class II, Groups E, F and G; temp code T3B (165C); Division 1. Also listed by C.S.A.

Mounting

1. Mount the motor securely on a firm and flat base. All ball and roller bearing normal thrust motors through frame 447 are mechanically capable of being mounted in any position. Consult with TIC for frames larger than 447. Special drains, seals, or support construction may be required on all sizes, subject to the environment.
2. Align the motor accurately, using a flexible coupling if possible. For drive recommendations, consult with the drive manufacturer, equipment manufacturer, or TIC Customer Support Center. See additional information in the section titled [Alignment Procedure on pg. 5](#). Ball bearings are recommended for direct coupled applications. Roller bearings may be used with flexible couplings — ensure proper alignment. Rigid couplings require extra allowance for thermal shaft growth toward the coupling. Skidding noise may result from the combination of internal bearing clearances and alignment tolerances. **DO NOT RUN A ROLLER BEARING WITHOUT A LOAD CONNECTED.**
3. V-belt Sheave Pitch Diameters should not be less than the values listed in [Table 1 on page 4](#) (NEMA recommended values), or calculated from the formula for frames above 445T.
4. Tighten belts enough to prevent slippage **only**. Belt speed should not exceed 6500 ft. per minute, or consult belt/sheave supplier.
5. Motors must not be subjected to vibration exceeding 0.5 G force. Motors are not to be mounted to shaker screens or vibrating equipment that exceeds 0.5 G force on the motor. Complete isolation is required.

Power Supply & Connections

1. Nameplate voltage and frequency should be consistent with the power supply. The motor will operate satisfactorily on line voltages within 10% of the nameplate value. The frequency shall be within 5% of the nameplate value. The combined variation shall not exceed 10%. A motor that is rated for 230 volts can be operated on 208-volt network systems per the nameplated amps, but with slightly modified performance characteristics.
2. Dual voltage and single voltage motors can be connected for the desired voltage by following the connection diagram shown on the nameplate. Alternate starting connections are shown in the conduit box or see the connection diagrams on [pg. 8](#) and [pg. 9](#).
3. Explosion Proof motors have Temperature Limiting Devices in the motor enclosure to prevent an excessive external surface temperature of the motor in accordance with UL standards. The **P1** and **P2** terminals of the thermal protectors should be connected to the motor control equipment. These are bimetal thermostats that are used for the primary thermal protection. Optional auxiliary thermistors embedded in the winding can only be used as secondary devices for thermal protection. The leads will be labeled **TP1** and **TP2** for thermistors. All supplementary device leads will be extended through the main terminal box.
4. Wiring of the motor and control, overload protection, and grounding should be in accordance with the National Electrical Code and local building codes. Explosion Proof motors have the internal terminal grounding connection inside of the main terminal box which must be used for the equipment grounding connection. An optional external grounding terminal on the feet is for a supplemental bonding connection, where local codes permit or require such a connection.
5. Lock out/Tag out and disconnect the motor from the power supply before opening the conduit box or performing any maintenance or repair on the motor.

6. Using a megohmmeter, test the insulation resistance of the motor before energizing. A minimum of 10 megohms is recommended.

Table 1. V-Belt Sheave Pitch Diameters (MG 1-14.42).

Frame Number	Horse Power at Synchronous Speed RPM			V-Belt Sheave (Inches)			
				Conventional A, B, C, D, and E		Narrow 3V, 5V, and 8V	
	3600	1800	1200	Min. Pitch Diameter	*Max. Width	Min. Pitch Diameter	**Max. Width
143T	1.5	1.0	0.75	2.2	4.250	2.2	2.250
145T	2 – 3	1.5 – 2	1.0	2.4	4.250	2.4	2.250
182T	3.0	3.0	1.5	2.4	5.250	2.4	2.750
	5.0	—	—	2.6			2.750
184T	—	—	2.0	2.4	5.250	2.4	2.750
	5.0	—	—	2.6			
	7.5	5.0	—	3.0		3.0	
213T	7.5 – 10	7.5	3.0	3.0	6.500	3.0	3.750
215T	10	—	5.0	3.0	6.500	3.0	3.750
	15	10	—	3.8		3.8	
254T	15	—	7.5	3.8	7.750	3.8	4.000
	20	15	—	4.4		4.4	
256T	20 – 25	—	10	4.4	7.750	4.4	4.000
	—	20	—	4.6			
284T	—	—	15	4.6	9.000	4.4	4.250
	—	25	—	5.0			
286T	—	30	20	5.4	9.000	5.2	4.250
324T	—	40	25	6.0	10.250	6.0	5.250
326T	—	50	30	6.8	10.250	6.8	5.250
364T	—	—	40	6.8	11.500	6.8	5.250
	—	60	—	7.4		7.4	5.250
365T	—	—	50	8.2	11.500	8.2	5.500
	—	75	—	9.0		8.6	
404T	—	—	60	9.0	14.250	8.0	7.250
	—	100	—	10.0		8.6	
405T	—	—	75	10.0	14.250	10.0	7.250
	—	100	—				
	—	125	—	11.5		10.5	
444T	—	—	100	11.0	16.750	10.0	8.500
	—	125	—			9.5	
	—	150	—	—		10.5	
445T	—	—	125	12.5	16.750	12.0	8.500
	—	150	—	—	—	10.5	
	—	200	—	—	—	13.2	

*Maximum sheave width - 2 (N-W)-1/4". **Maximum sheave width = N-W.
 Sheave ratios greater than 8:1, or with a center-to-center distance less than the diameter of the large sheave, should be referred to TIC. Sheaves must be mounted close to the shaft shoulder.

For motors above 445T frame with narrow V-belts:

$$\text{Sheave Diameter (inches)} = 25 (H/N_R)^{1/3}$$

Where:

H = Rated motor HP

N_R = Rated motor speed in RPM

Maximum sheave width = N-W of shaft. Contact TIC for other sizes.

$$\text{Belt Speed (Ft/min)} = (\text{Shaft RPM} \times 3.14 \times \text{Sheave Diameter}) / 12.$$

Figure 1. Shaft Extension Loads Due to Transmission of Power.

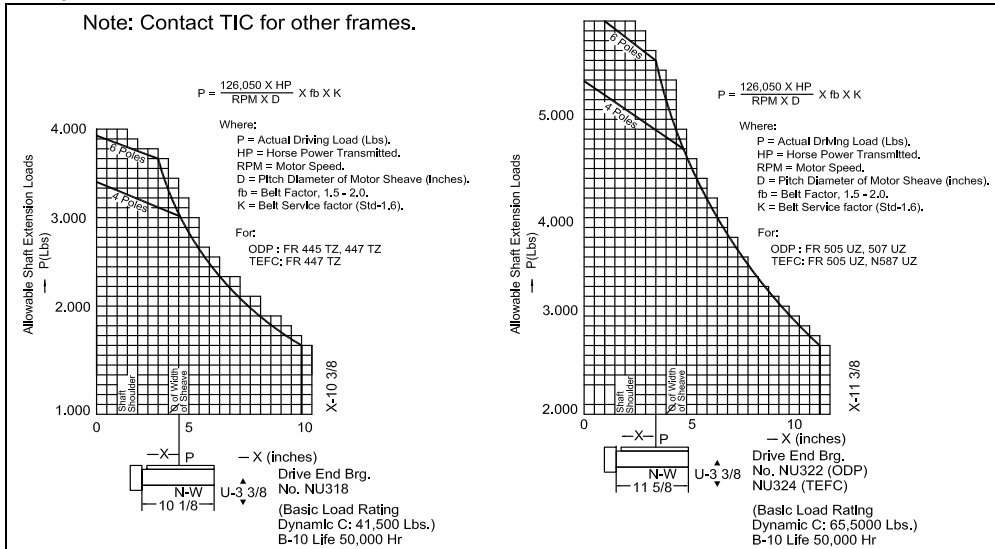

Alignment Procedure

Motor Leveling & Coupling Alignment

When the base has been adjusted, leveled, and grouted, the correct motor leveling and coupling alignment are obtained with the aid of shims between the motor and the base. To give the motor proper support, it is important that the base and shims combine to create a level and stable platform.

Rigid Coupling

Shaft Alignment

Extreme care must be taken to obtain correct shaft alignment when using rigid couplings. Circular concentric peripheral surfaces of the two coupling halves must indicate correct alignment to within 0.0005 inches to 0.001 inches when the two coupling halves are rotated together. The separation between the faces of the two coupling halves must also be maintained within the same tolerance.

The alignment may be checked by utilizing a dial indicator, or with the aid of a straight-edge and thickness gauge or feelers as shown on pg. 7.

The preferred method of checking alignment is with the dial indicator. Bolt the indicator to one of the coupling halves and indicate the position of the dial button on the opposite coupling half with a chalk mark. Set the indicator dial to zero at the first position and then rotate both halves of the coupling to a new position where a reading is to be made. All readings must be made with the dial button located at the chalk mark. At least six readings are to be taken.

A variation in the dial reading at different positions of coupling rotation will indicate whether the machine has to be raised, lowered, or moved to one side or another to obtain alignment of the circular concentric peripheral surfaces of the two coupling halves within the specified tolerance.

Coupling Faces

In addition to the above check, a check of the separation of the coupling faces must be made to establish correct alignment. The separation between the faces of the coupling may be checked with a dial indicator fastened to one coupling half and a

reference surface fastened to the other coupling half. Mark the location of the dial button on the reference surface and make all readings with the indicator in this position.

Set the dial of the indicator to zero for the first reading and use this as the reference. Be sure to rotate both halves of the coupling the same amount, aligning the bottom of the indicator and the mark on the reference surface for each of six readings. A variation of the readings at different positions will indicate how the machine has to be adjusted to obtain correct alignment. After each adjustment of the motor, repeat the above procedure to ensure that the correct alignment and leveling have been obtained.

Flexible Coupling

Units coupled through flexible couplings should be aligned as accurately as possible. The two halves should indicate correct alignment to within 0.002 inches on both the circular concentric peripheral surfaces and the separation between faces. Although most flexible couplings will withstand greater misalignment than rigid couplings, extreme misalignment can cause vibration possibly resulting in failure of motor bearings and/or shaft.

If the method shown in [Figure 2 on pg. 7](#) is used to check alignment of the machines, correct alignment exists when:

- The peripheries of the coupling halves are true circles of the same diameter and if the faces are flat.
- The separation between the faces is held to within the specified tolerance at all points and a straight-edge lies squarely across the rims at any point.

Non-parallel faces will be indicated by a variation in separation of the coupling halves as they are rotated, and a difference in height of the coupling halves will be indicated by the straight-edge and feeler gauge test.

When the coupling halves have been correctly aligned with the motor feet bolted in position, place temporary bolts in two coupling holes for clamping the halves together. Then, ream for a light drive fit through both halves for regular coupling bolts.

The preferred method of measuring coupling alignment is with a dial indicator as shown in [Figure 1](#).

Clamp the dial indicator to the coupling as indicated below to measure the circular concentric peripheral surfaces of the coupling halves for parallel alignment.

Also, as shown in [Figure 1](#), clamping a reference surface to the opposite coupling half allows the dial indicator to be used for measuring the separation of the coupling halves for axial alignment.

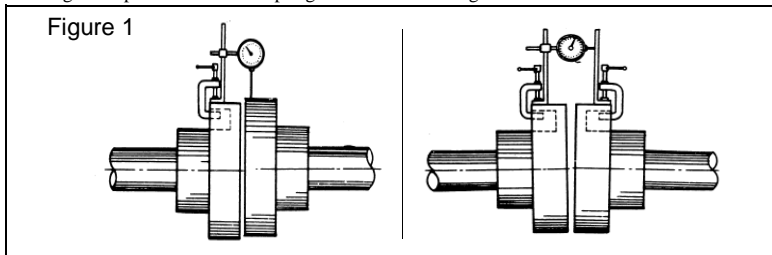

Balance (Direct Coupled Units)

TIC motors are balanced at the factory to standard NEMA commercial tolerances. However, if direct coupling units have been disassembled in the field and are not reassembled with the shafts in the same position as they were originally, an unbalanced condition may occur.

To correct this condition, disconnect the coupling halves and rotate one shaft 90° with respect to the other shaft. Reconnect the coupling and run the motor. If not corrected, repeat the procedure until normal operation resumes.

The straight-edge or thickness gauge or feeler gauge is an alternative method of measuring coupling adjustment as shown in [Figure 2 on pg. 7](#).

Use a straight-edge and thickness gauge or feeler gauge to check the alignment of the circular concentric peripheral surfaces of the coupling halves as shown below. The separation between the faces of the coupling halves can be measured as shown.

Rigid Coupling Tolerances 0.0005 inch to 0.001 inch. Flexible Coupling Tolerance: 0.002 inch.

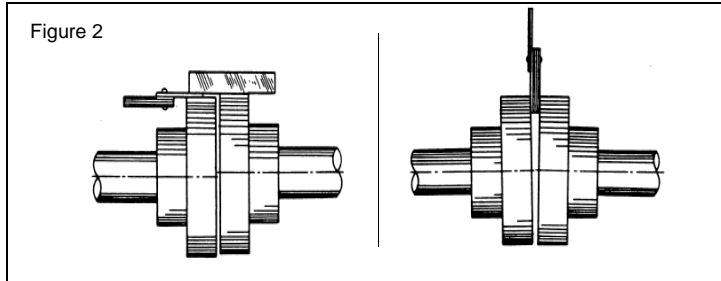

Warnings

⚠ WARNING

BEFORE STARTING MOTOR, REMOVE ALL UNUSED SHAFT KEYS AND LOOSE ROTATING PARTS TO PREVENT THEM FROM FLYING OFF.

CAUTION: CHECK DIRECTION OF MOTOR ROTATION BEFORE COUPLING MOTOR TO LOAD. TO REVERSE THE MOTOR ROTATION, REVERSE ANY TWO OF THE THREE LEADS TO THE POWER PHASES. IF THE MOTOR IS NOT BI-DIRECTIONAL, CONFIRM THE CONNECTION DIAGRAM AND ROTATION ARROW, OR CONTACT TIC.

⚠ WARNING

ROTATING PARTS, SUCH AS COUPLINGS, PULLEYS, EXTERNAL FANS, AND UNUSED SHAFT EXTENSIONS, SHOULD BE PERMANENTLY GUARDED AGAINST ACCIDENTAL CONTACT WITH HANDS OR CLOTHING. THIS IS PARTICULARLY IMPORTANT WHERE THE PARTS HAVE SURFACE IRREGULARITIES SUCH AS KEYS, KEYWAYS OR SET SCREWS.

⚠ WARNING

WHEN A LIFTING MEANS IS PROVIDED FOR HANDLING THE MOTOR OR GENERATOR, IT SHOULD NOT BE USED TO LIFT THE MOTOR OR GENERATOR PLUS ADDITIONAL EQUIPMENT SUCH AS GEARS, PUMPS, COMPRESSORS, OR OTHER DRIVEN EQUIPMENT.

⚠ WARNING

THE FRAMES AND OTHER METAL EXTERIORS OF MOTORS AND GENERATORS (EXCEPT FOR INSULATED PEDESTAL BEARINGS) USUALLY SHOULD BE GROUNDED TO LIMIT THEIR POTENTIAL TO GROUND IN THE EVENT OF ACCIDENTAL CONNECTION OR CONTACT BETWEEN LIVE ELECTRICAL PARTS AND THE METAL EXTERIORS.

⚠ WARNING

WHEN CAREFUL CONSIDERATION OF THE HAZARDS INVOLVED IN A PARTICULAR APPLICATION INDICATE THE MACHINE FRAMES SHOULD NOT BE GROUNDED OR WHEN UNUSUAL OPERATING CONDITIONS DICTATE THAT A GROUNDED FRAME CANNOT BE USED, THE INSTALLER SHOULD MAKE SURE THAT THE MACHINE IS PERMANENTLY AND EFFECTIVELY INSULATED FROM GROUND. IN THOSE INSTALLATIONS WHERE THE MACHINE FRAME IS INSULATED FROM GROUND, IT IS RECOMMENDED THAT APPROPRIATE WARNING LABELS OR SIGNS BE PLACED ON THE EQUIPMENT OR IN THE AREA OF THE EQUIPMENT BY THE INSTALLER.

⚠ WARNING FOR EXPLOSION-PROOF MOTOR

Disconnect power before working on motor-driven equipment. This motor is equipped with an automatic temperature-limiting device. The National Electrical Code and Underwriter's Laboratories require connection of leads P1 and P2 into the control circuit of a manual reset starter per the following diagram.

Klixon Type	AC Volt	Volt Amp Rating
9700K	120-600 Volt	720 VA

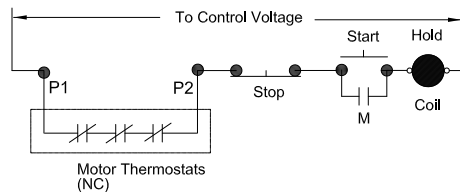

Note: Frames 256T and smaller have two thermostats.

Figure 3. Typical Connection Diagrams.

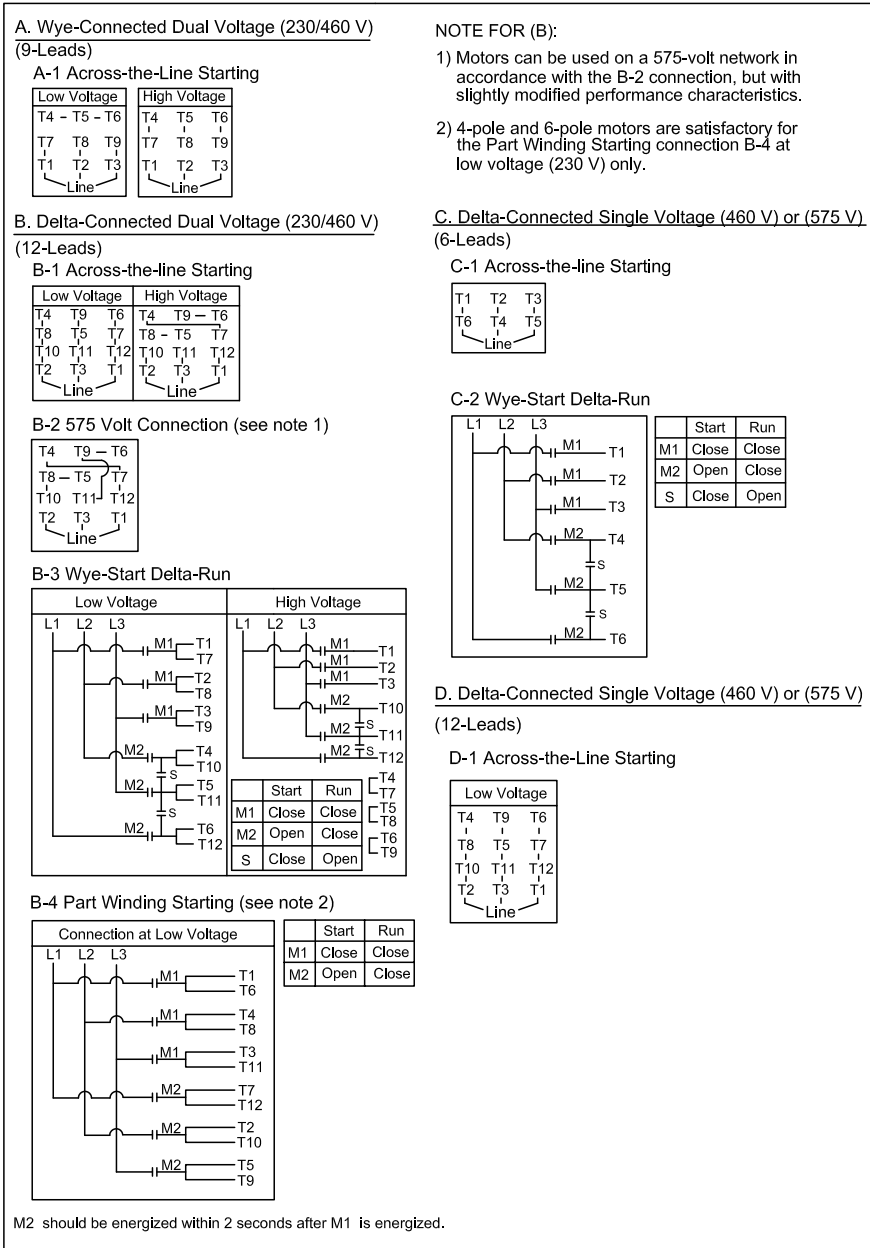
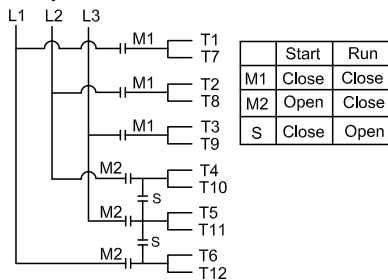
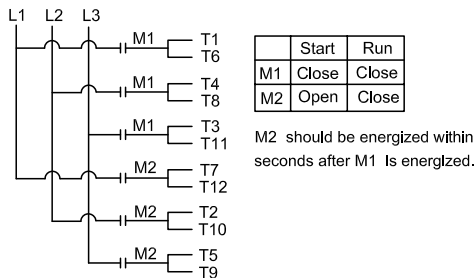

Figure 4. Typical Connection Diagrams (Cont.)

D-2 Wye-Start Delta-Run



D-3 Part Winding Starting (4-Pole and 6-Pole Motors)



**E. Wye-Connected (460 V) or (575 V)
(3-Leads)**

E-1 Across-the-Line Starting

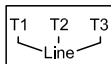

F. Delta-Connected (460 V) or (575 V)

F1 Across-the-Line Starting

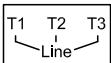

NOTE

Frames N449T-5811UZ will have 3 leads with multiple cables in each lead numbered the same in each respective lead cable.

Maintenance

Inspection

Inspect motor at regular intervals. Keep the motor clean and the vent openings unobstructed.

Lubrication

Frames 143T – 256T are furnished with double sealed or shielded ball bearings that are lubricated with lithium-based grease prior to installation. Grease fittings are not supplied and bearings are designed for average 100,000 hours operation under standard conditions (see [Table 2](#)).

Frames 284T – 5811UZ are furnished with double shielded, open ball, or roller bearings. Depending on HP size and/or the operating speed, it may be necessary to relubricate anti-friction bearings periodically (see [Table 2](#)).

These motors are supplied with provisions for greasing and have been lubricated prior to shipping. However, before start up, it is recommended that approximately 30 grams (1 oz.) of grease be applied because of possible settling of grease during storage. Any oil leakage around bearing caps indicate overpacking — excess grease should be purged by operating motor temporarily with relief open.

Table 2. Relubrication Frequency.

Sync. RPM Range	Frame Range	Type Of Service		Service Conditions	
		Standard Duty	Severe Duty		
3600	143T - 256T	5 Years	3 Years	Standard Duty	Eight hours per day, light to normal loading, clean condition free of dust.
	284TS - 286TS	12 Mos.	4 Mos.		
	324TS - N5811USS	9 Mos.	3 Mos.	Severe Duty	Twenty-four hours per day, or light to normal shock loading vibration, exposure to dirt or dusty conditions.
1800	143T - 256T	7 Years	3 Years		
	284T - 326T	4 Years	1.5 Years		
	364T - 365T	2.5 Years	10 Mos.		
	404T - 447TZ	2 Years	8 Mos.		
1200 and Slower	505US - N5811UZ	1.5 Years	6 Mos.	Very Severe Duty	For very severe conditions where the motor is subject to high vibration or heavy shock loading and vibration use 1/3 of the value shown in the severe duty table
	143T - 256T	7 Years	3 Years		
	284T - 326T	4 Years	1.5 Years		
	364T - 447TZ	3 Years	1 Year		
	505US - N5811UZ	2 Years	8 Mos.		

Note: Typical schedule provided. See nameplate for actual schedule and type of grease, if applicable.

Instructions for Lubricating

Toshiba motors (284T – 5811UZ) are furnished with grease fittings. Before greasing, be sure fittings are clean and free of dirt.

Remove the grease relief plug or plate and, using a low pressure grease gun, pump in the required grease amount. Do not over grease. Relubrication intervals are specified in [Table 2](#). After relubricating, allow the motor to run for 10 minutes before replacing relief hardware. All EQP 841 motors have grease fittings. See the **Motor Relubrication** document **#MDS-O-0001** for details on both standard horizontal and vertical motor bearings.

Recommended Greases for Standard Applications

Unless otherwise specified by the grease nameplate of the motor, use the following greases for the listed temperature range. The TIC standard, 840, and 841 motors are greased at the factory with the polyurea base Mobil Polyrex[®] EM grease.

Operating Ambient Temp. -30° C – 50° C.	
Chevron [®] SRI	Chevron Corp.
Mobil Unirex [®] N 2	Exxon Mobil Corp.
Mobil Polyrex [®] EM	Exxon Mobil Corp.
Shell Dolium [®] R	Shell Oil Co.
Mobilith SHC [®] 100	Exxon Mobil Corp.

Recommended Greases for Special Applications

The following greases are recommended for special applications only and should be used only for motors specifically built for such conditions.

Minimum Ambient Temperature -60° C	
Beacon [™] 325	Exxon Mobil Corp.
Maximum Ambient Temperature 90° C	
Dow Corning [®] 44	Dow Corning Corp.
Mobil Unirex [®] S 2	Exxon Mobil Corp.
Triton [®] 460	ConocoPhillips Co.
Mobilith SHC [®] 460	Exxon Mobil Corp.

 **WARNING:** In general it is not recommended to mix greases of different brands. The mixing of different types of thickeners may destroy the composition and physical properties of the grease. In the event that a different grease is required by the end user, the following steps can be taken. Using the instructions for lubrication, open grease outlet and purge the system as much as possible of the old or unwanted grease. Repeat this same operation after 1 week of service. Consult Toshiba Customer Support Center for further recommendations on grease compatibility.

WARRANTY

Toshiba International Corporation (TIC) warrants that the received Goods will be free of defects in materials and workmanship.

This warranty expires eighteen (18) months after the date that the Goods are received by the Purchaser or twelve (12) months after the Goods are placed into operation, whichever occurs first. Neither shall exceed 18 months from the date of receipt of the Goods.

Goods that are received in an unacceptable condition shall, at the sole discretion of TIC, be repaired, replaced, updated, or have the purchase price refunded.

To file a claim, the Purchaser must (1) promptly notify TIC in writing of the nonconformity, (2) furnish TIC satisfactory proof of the nonconformance, and (3) if requested by TIC, return the nonconforming equipment or part to TIC and pay all expenses incurred in connection with such return.

The repaired/replaced item, part, or software, shall be delivered, free of charge, to the Purchaser, FCA TIC designated facility or at TIC's option, FCA TIC-authorized service shop (INCOTERMS 2010). Purchaser shall pay all costs following such delivery, including, without limitation, all handling, transportation, assembly, installation, insurance, testing, and inspection charges.

The warranty excludes (1) normal wear and tear; (2) Goods that have not been properly stored, assembled, installed, serviced, maintained, operated, or used within the limits of rated capacity and normal usage; (3) Goods not used in accordance with current operating and maintenance instructions furnished by TIC, and (4) Goods that have been altered or modified in any manner without the written consent of TIC.

THE FOREGOING OBLIGATION TO REPAIR, REPLACE, OR REFUND THE PURCHASE PRICE PAID FOR THE GOODS SHALL BE THE SOLE AND EXCLUSIVE REMEDY OF THE PURCHASER, ITS CUSTOMERS AND USERS OF THE GOODS FOR THE NONCONFORMANCE OF THE RECEIVED GOODS.

TIC SHALL HAVE NO OBLIGATION TO DISASSEMBLE ANY NONCONFORMING GOODS OR TO INSTALL ANY REPAIRED OR REPLACEMENT PART, EQUIPMENT OR SOFTWARE OR TO PAY ANY COSTS INCURRED IN CONNECTION WITH SUCH DISASSEMBLY OR INSTALLATION.

THERE ARE NO OTHER WARRANTIES AND TIC HEREBY EXPRESSLY DISCLAIMS ALL OTHER EXPRESS, STATUTORY, AND IMPLIED WARRANTIES, INCLUDING, WITHOUT LIMITATION, IMPLIED WARRANTIES OF MERCHANTABILITY AND FITNESS FOR A PARTICULAR PURPOSE.

RENEWAL PARTS

1. Use only genuine Toshiba renewal parts.
2. When ordering, specify complete motor information. Model Number and Serial Number are a minimum requirement. Specify quantity and describe part.
3. For information and service contact the Toshiba Customer Support Center.



WARNING

Explosion-Proof Motors are constructed to comply with the UL Label Service Procedure Manual. Repair of **Explosion-Proof Motors** must be made by the manufacturer or UL-listed service center to maintain the UL listing.

Customer Support

The TIC Customer Support Center is open from 8 a.m. to 5 p.m. (CST), Monday through Friday.

The toll free number is US (800) 231-1412/(713) 466-0277 — Fax (713) 466-8773.

For after-hours support follow the directions in the outgoing message when calling.

You may also contact Toshiba International Corporation by writing to:

Toshiba International Corporation
13131 West Little York Road
Houston, Texas 77041-9990
Attn: Motors.

For further information on Toshiba International Corporation's products and services, please visit our website at www.toshiba.com/TIC.



NO POSTAGE
NECESSARY
IF MAILED
IN THE
UNITED STATES

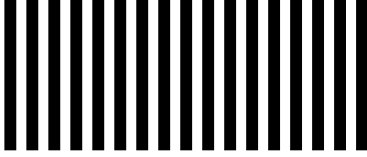

BUSINESS REPLY MAIL
FIRST-CLASS MAIL PERMIT NO. 3142 HOUSTON, TX

POSTAGE WILL BE PAID BY ADDRESSEE

ATTN PRODUCT REGISTRATION
TOSHIBA INTERNATIONAL CORPORATION
13131 W LITTLE YORK ROAD
HOUSTON TX 77041-9988



TOSHIBA PRODUCT WARRANTY REGISTRATION

Thank you for purchasing a Toshiba International Corporation product. This Product Warranty Registration form documents your Toshiba product's current warranty. Your completed registration form can be submitted electronically or by mail. To submit the Product Warranty Registration form electronically, please complete this form online at <http://www.toshiba.com/ind/warranty>.

All items marked with an asterisk (*) are required.

SECTION I • Company Information

Company Name: _____

*First Name: _____ *Last Name: _____

*Title: _____

*Address: _____

*City: _____ *State: _____ *ZIP Code: _____

*Country: _____

*Work Phone Number: () _____

*Email Address: _____

Company Website: _____

SECTION II • Product Information

*Product: Drive Motor UPS Other: _____

*Model Number: _____

*Serial Number: _____

*Date of Installation: _____

*Company Purchased From: _____

City: _____ State: _____ ZIP Code: _____

Country: _____

Authorized Start-Up Agent Certificate Number: _____

Section III • Additional Information

If you would like to receive additional information about your recently purchased Toshiba product and/or information on additional Toshiba Industrial products and services, please complete the following sections.

- Additional Information on Product Offerings:
 - Product Repair Training
 - Product Application Training
 - Extended Warranty Options
 - Maintenance Agreements
- Additional Information on Toshiba Industrial Products:
 - Motors
 - Motor Starters
 - Drives
 - Solid State Starters
 - Instrumentation
 - Programmable Logic Controllers
 - Uninterruptible Power Systems
 - Contactors
 - Other: _____

PN4468-001

TOSHIBA

Leading Innovation >>>